

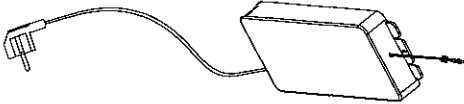

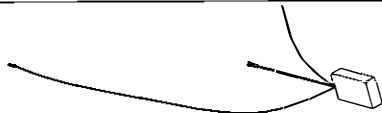

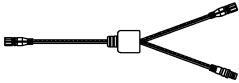
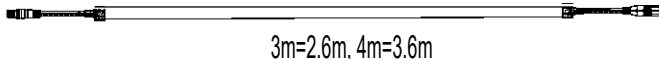
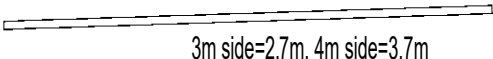

DANCOVER[®]

.com

Manual
for
LED Light
for
Pergola Gazebo San Pablo
3x3m, 3x4m and 4x4m

Part List for LED Light for Pergola Gazebo San Pablo 3x3m, 3x4m and 4x4m

NO.	PART NAME	DRAWING	QTY
1	12V switching power supply+ Power cord with plug+power cable of controller		1
2	LED controller + power cable		1
3	Tee joint		1
4	LED stripes	 3m=2.6m, 4m=3.6m	4
5	Cover	 3m side=2.7m, 4m side=3.7m	4
6	Stripe bracket		8
7	Screw for stripe bracket		8
8	Transparent card		32
9	Self-drilling screw	 ST4.2*25	6
10	One-botton emitter		1

Step 1: Install the LED stripe 4 onto the front and rear beam C

(Tips: Distance of each transparent card is 20-25cm)

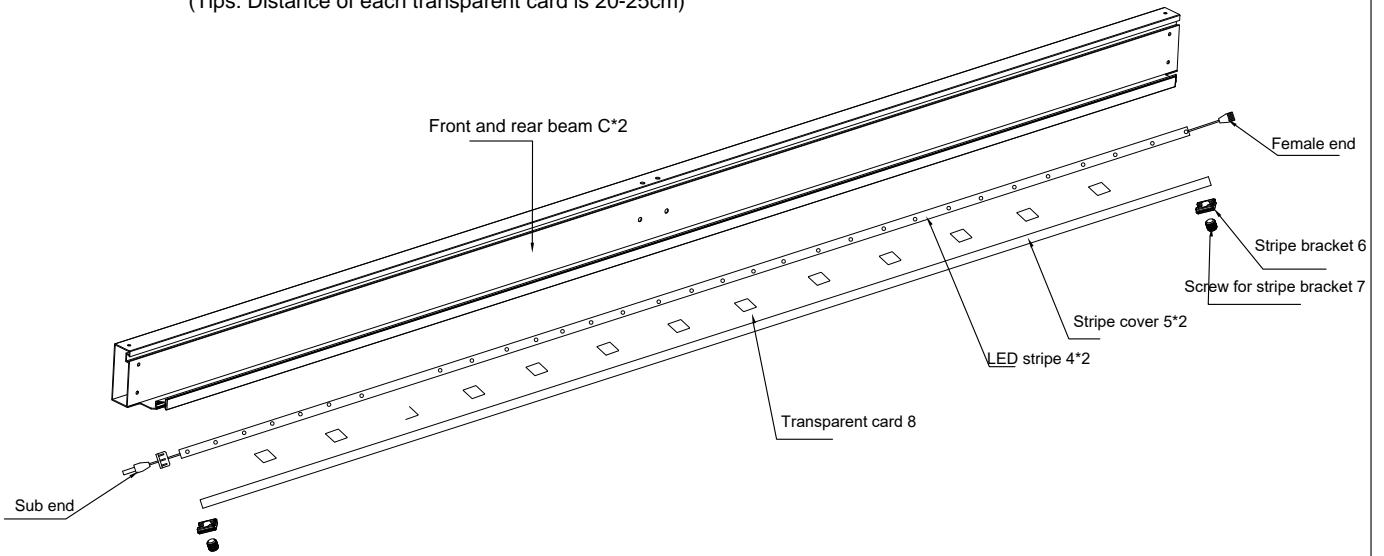

Step 2: Install the LED stripe 4 onto the right beam B2

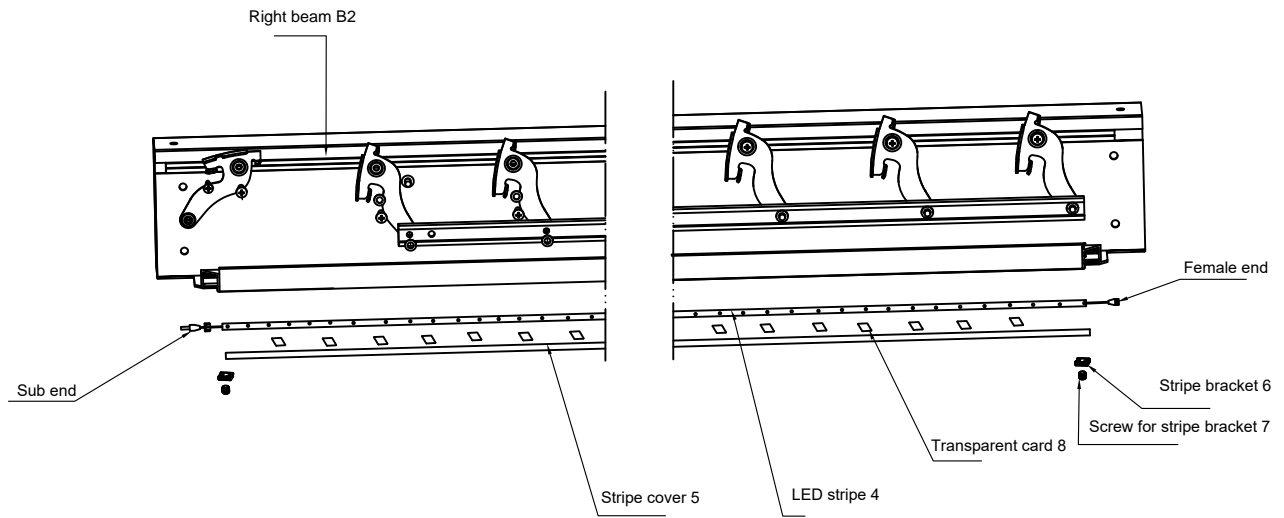

Step 3: Install the LED stripe 4 onto the left beam B1

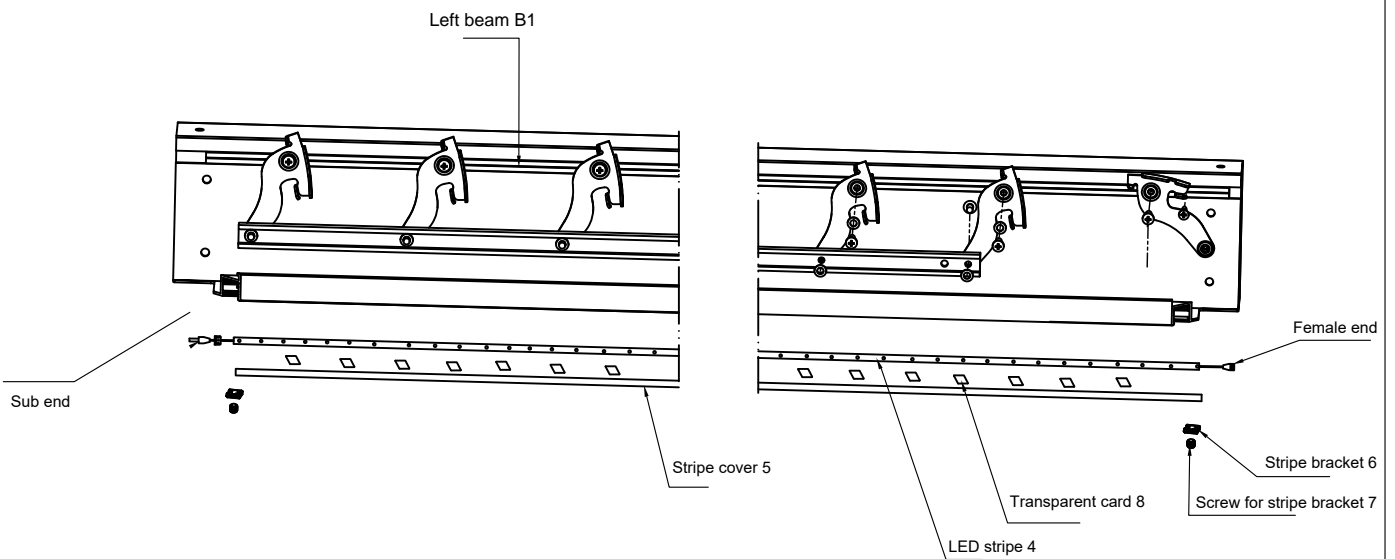

Step 3:
Connect the sub end of the LED cable 2 with the female end of the Tee joint 3; then connect the female end of the beam B1 and the sub end of the beam C with the sub end and female end of Tee joint separately.

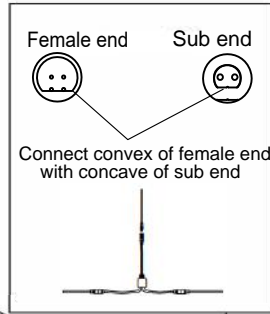

Step 2:
Connect the power cable 1 with the LED controller 2, then tighten the screw cap on sub end with the female end of the LED controller.

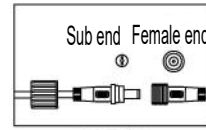

Step 1: Connect the female end on the beam C with the sub end on the B2; Except that the end of beam B1 and beam C need not be connected, other light bars shall be connected and tightened in clockwise order.

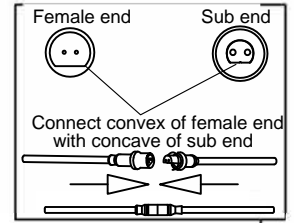

Step 4:
Fix the power supply 1 and LED controller 2 on the beam C with screws 9 separately; Plug in and adjust the light color brightness by the emitter 10.

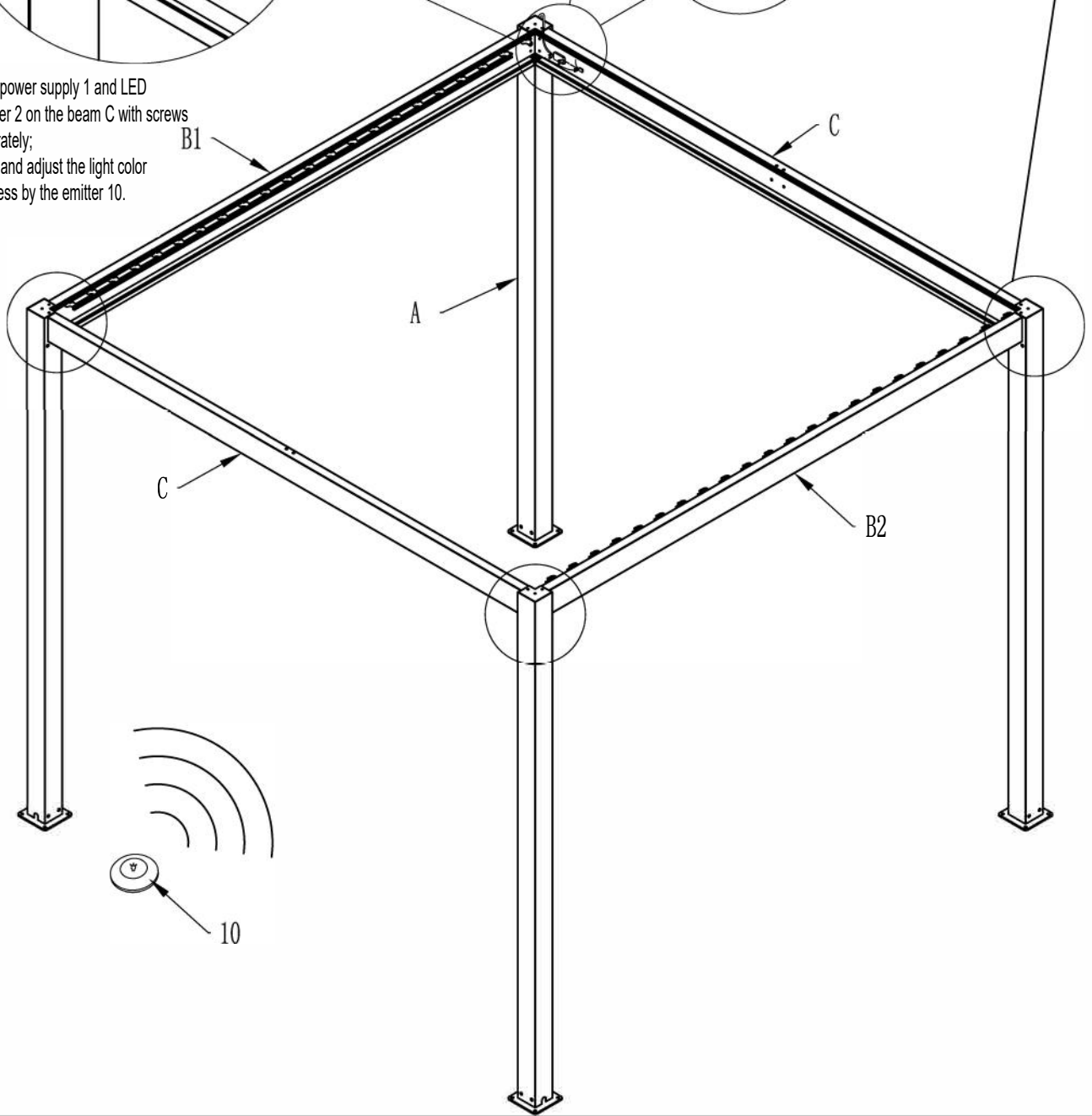

10



QTY: 1PC

9



QTY: 6PCS

Contact information

Austria



Belgium



Croatia



Denmark



Estonia



Finland



France



Germany



Ireland



Italy



Latvia



Lithuania



Nederland



Norway



Poland



Portugal



Spain



Sweden



Switzerland



UK

