

MODULARO™

Wood Cabin Stavanger
3x2,5x2,45m



Art.Nr. WC165571

Groundplan - Grundplan - Plan de masse - Planimetria - Plattegrond - Põhiplaan

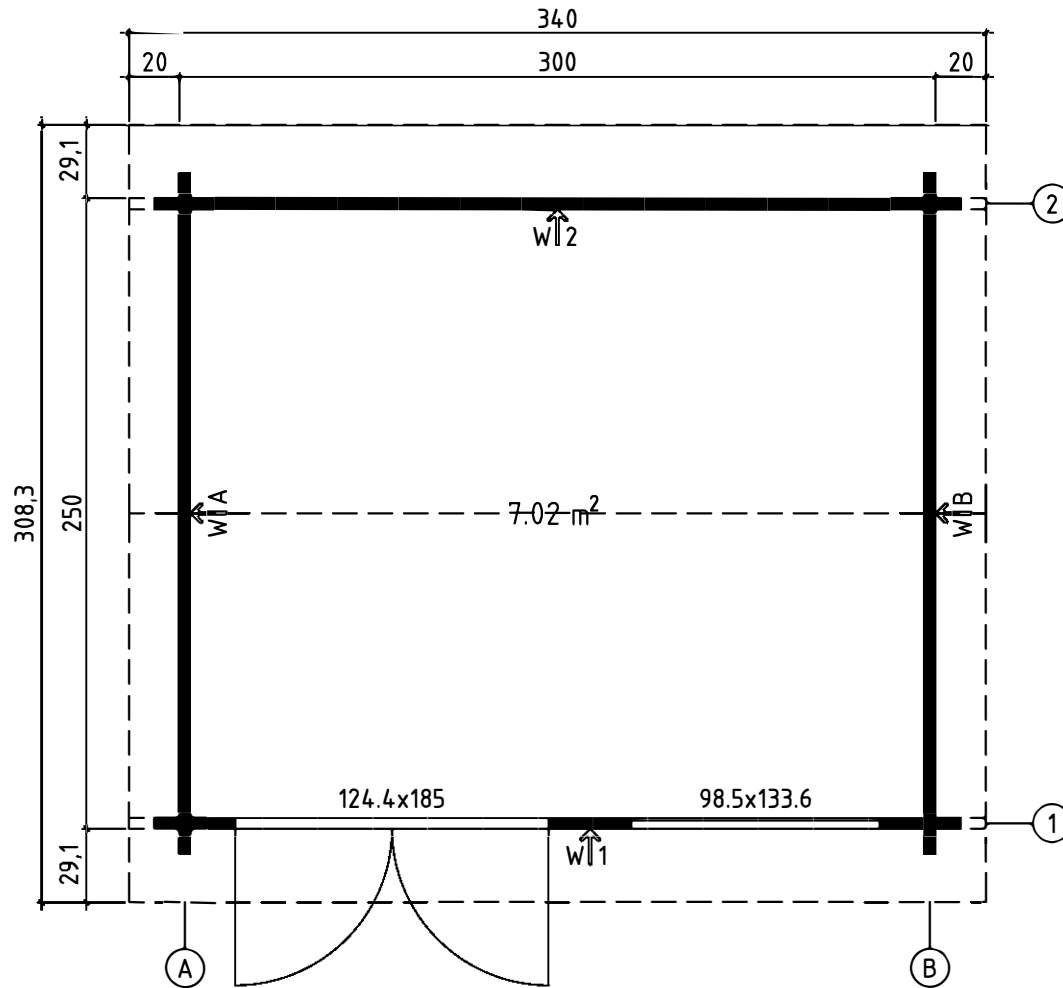

Art.Nr. WC165571

Foundation - Fundament - Fondation - Fondamenta - Fundering -
Immutatud alusraam

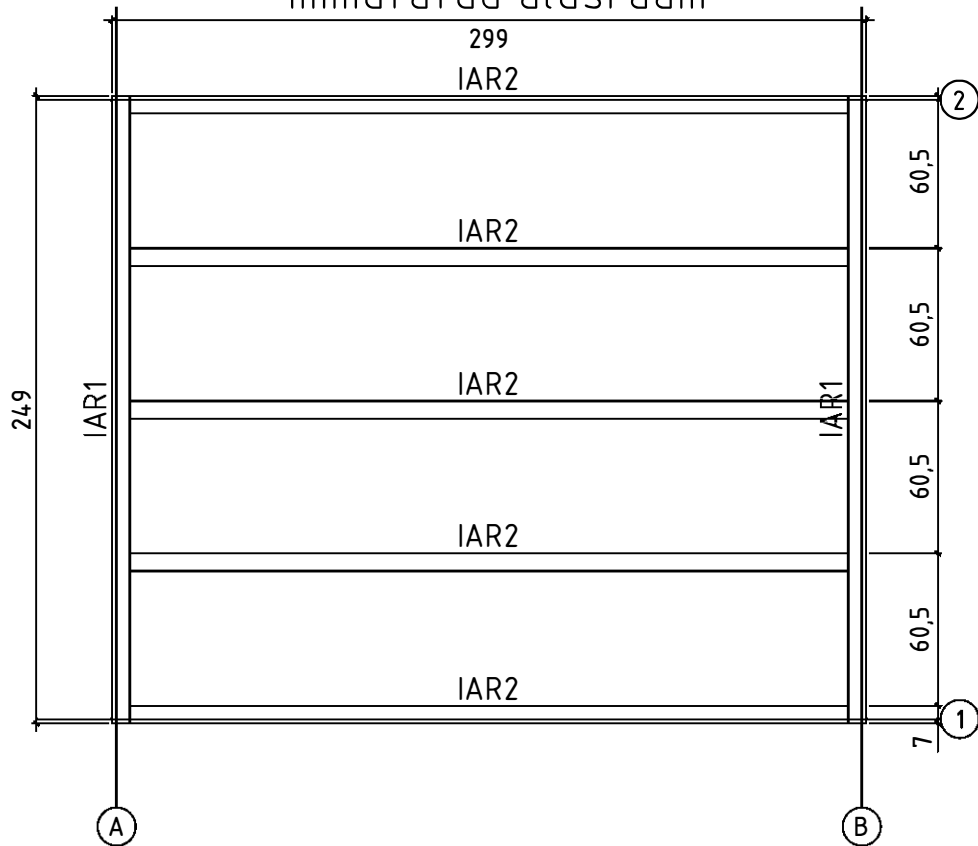

Floor boards - Fussbodenbretter - Plan pose plancher - Pavimento -
Vloerhout - Põrandalaudis

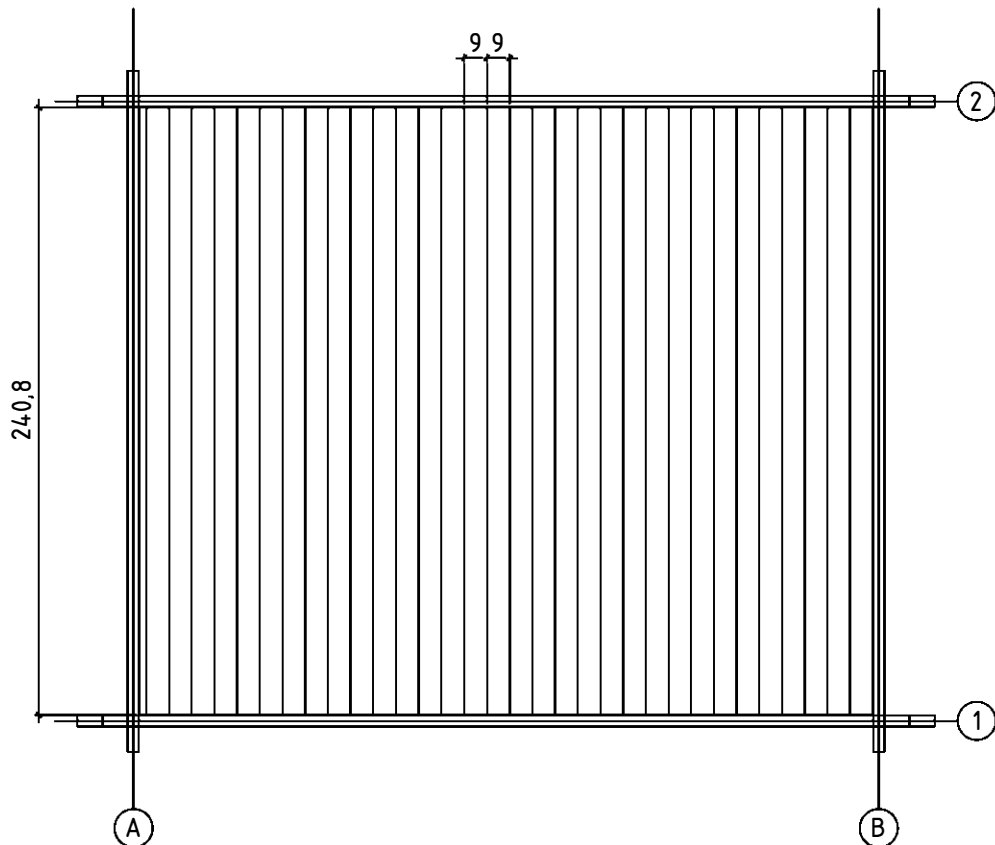



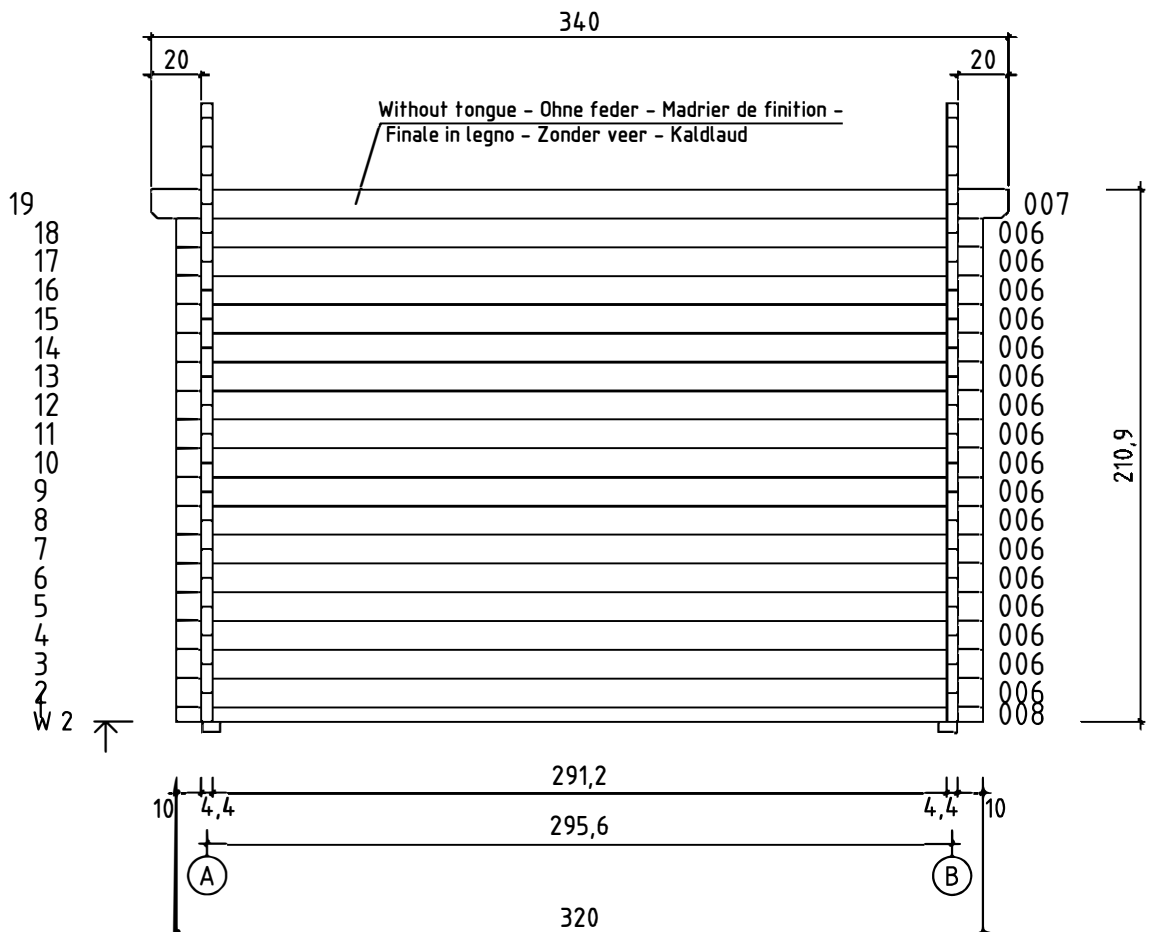
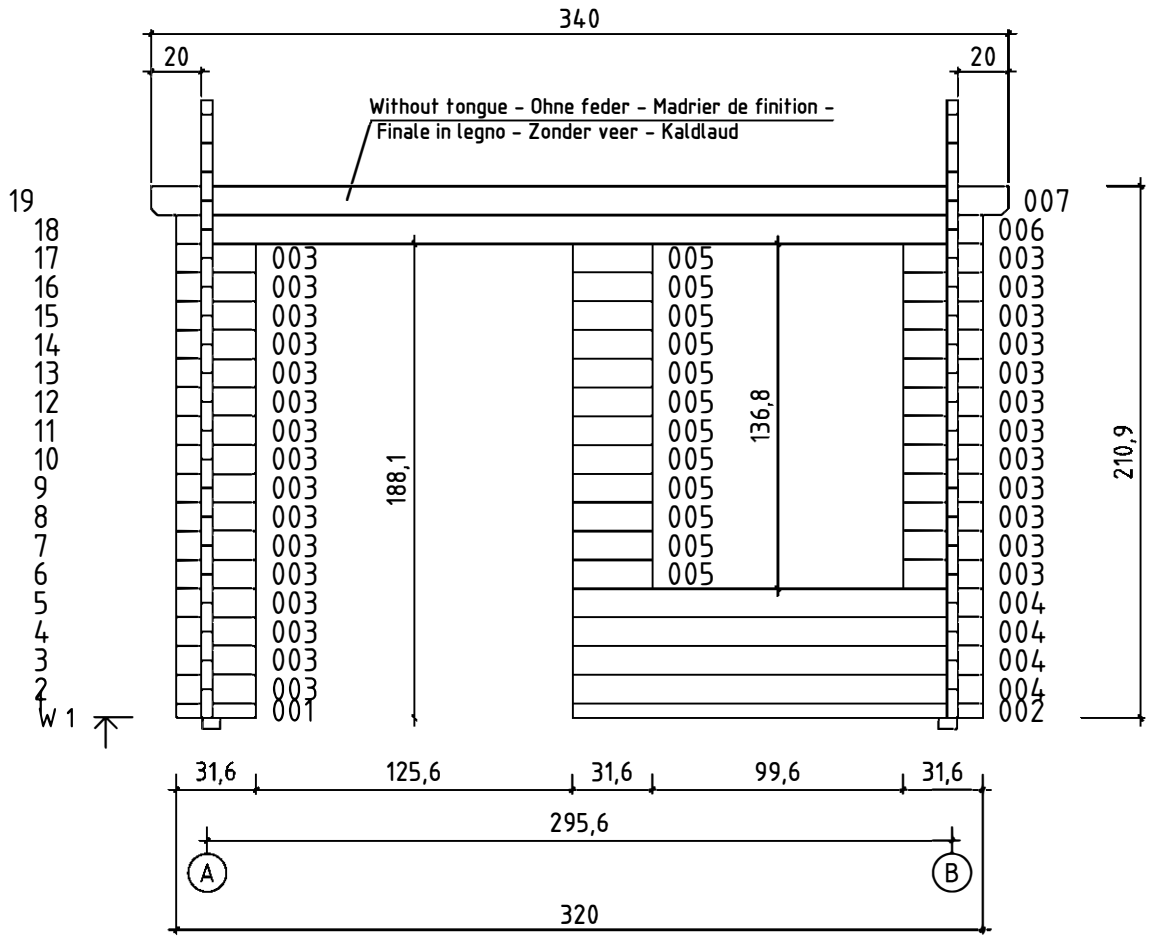



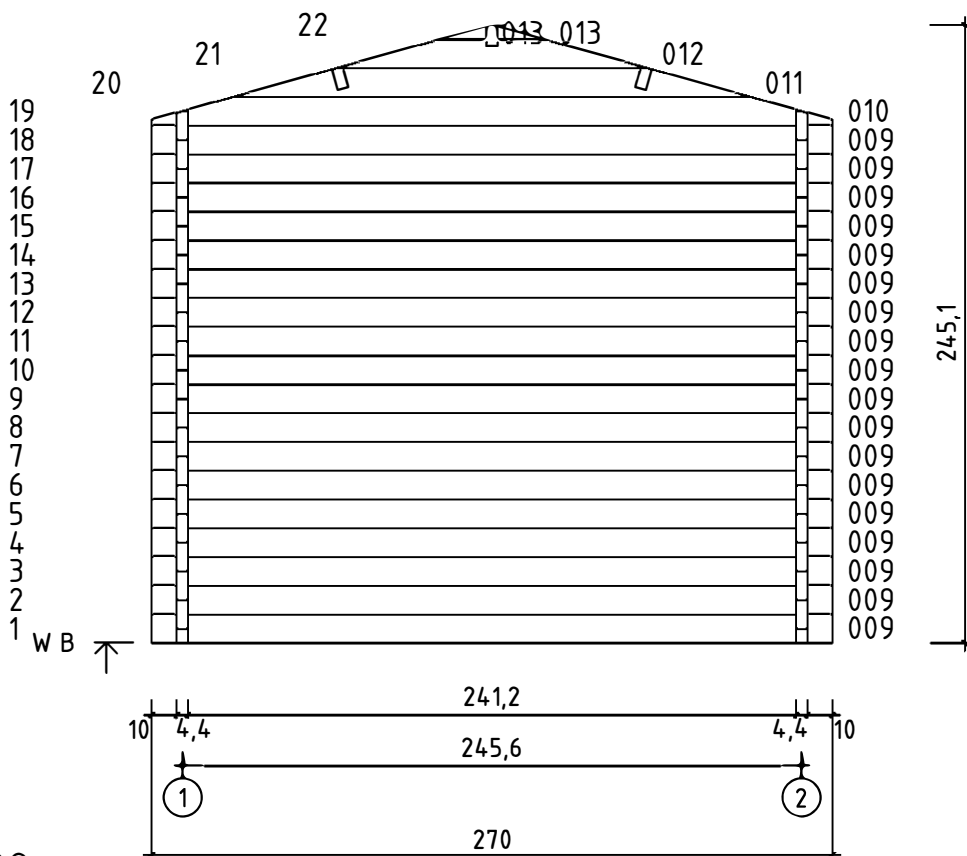
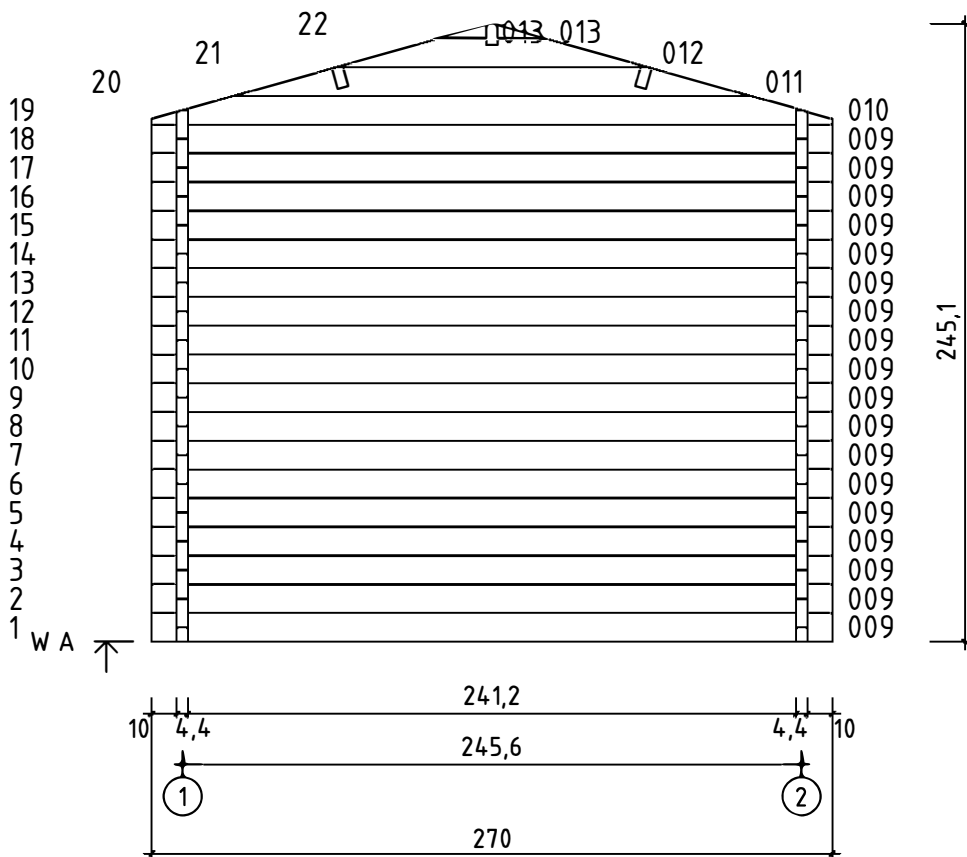

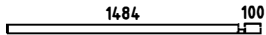

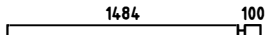

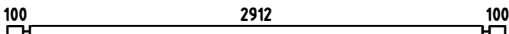
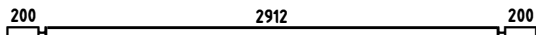
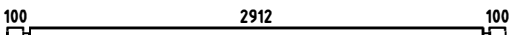
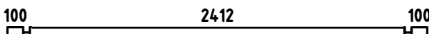
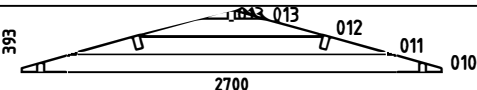

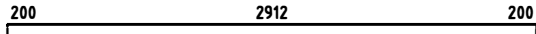

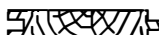

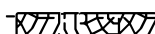
Art.Nr. WC165571

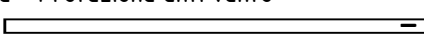
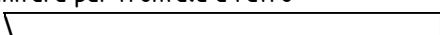



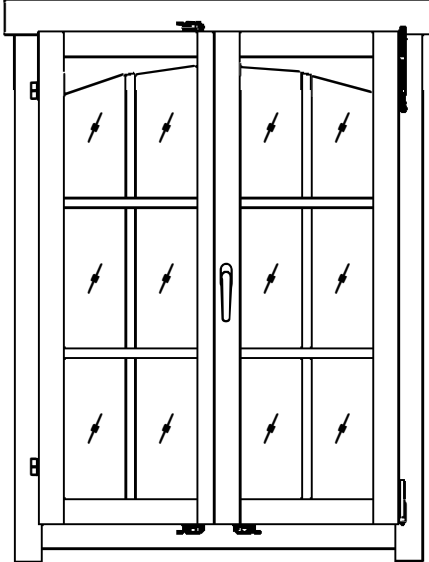
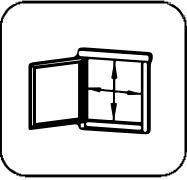

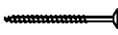



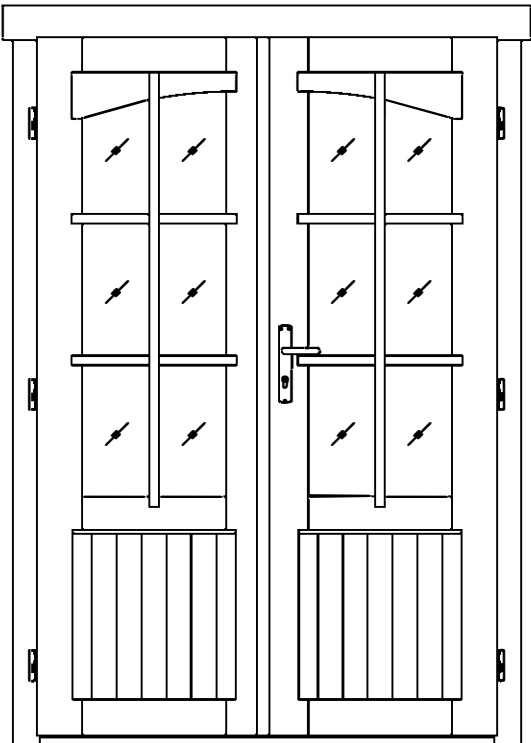
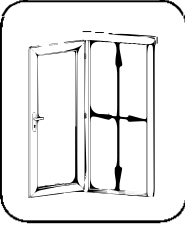

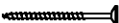
Art.Nr. WC165571



| Pos | Piece list - Stückliste - Liste des pièces - Elementi - Stuklijst - Tükitalabel Art.Nr. WC165571 6/7 | Q | P (mm) | L (mm) |
|--------------|--|--------|-----------|-----------|
| 001 |  | 1 | 44x57 | 316 |
| 002 |  | 1 | 44x57 | 1628 |
| 003 |  | 28 | 44x114 | 316 |
| 004 |  | 4 | 44x114 | 1628 |
| 005 |  | 12 | 44x114 | 316 |
| 006 |  | 18 | 44x114 | 3200 |
| 007 |  | 2 | 44x120 | 3400 |
| 008 |  | 1 | 44x57 | 3200 |
| 009 |  | 36 | 44x114 | 2700 |
| WA-1 WB-1 |  | 1 1 | | |
| IAR2 | Foundation - Fundament - Fondation - Fondamenta - Fundering - Immutatud alusraam  | 5 | 70x45 | 2850 |
| IAR1 | Foundation - Fundament - Fondation - Fondamenta - Fundering - Immutatud alusraam  | 2 | 70x45 | 2490 |
| A-PR1 | Roof beam - Dachbalken - Panne de toit - Perlina del tetto - Gordingen / dakbalk - Pärilin  | 3 | 44x140 | 3400 |
| | Floor boards - Fussbodenbretter - Lame de plancher - Pavimento - Vloerhout - Põrandalaud  | 33 | 90x18 | 2408 |
| | Roof boards - Dachbretter - Voliges - Perlina per tetto - Dakhout - Katuselaud  | 76 | 90x18 | 1600 |
| | Floor fillet - Fussbodenteiste - Corniere de finition du plancher - Finitura per pavimento (battisco pa) - Vloerafwerkljst - Põrandaliist  | | 18x18 | 10.63 |
| | Roofing felt fillet - Dachpappenleiste - Baguette de fixation du feutre bitumeux - Asse per fissaggio guaina bituminosa - Afdekljst asfaltpapier - Katusepapiliist  | 4 | 18x58 | 1650 |
| TB-1 | Fascia board - Traufbrett - Bandeau de toit - Finitura lati tetto - Gevelljst Räästalaud  | 2 | 18x90 | 3400 |
| DRV-1 | Roof edge reinforcement - Dachrandverstärkung - Corniere de renfort de bord de toit - Rinforzo x tetto - Dakrand versterking - Räästatugevdus  | 2 | 28x34 | 3400 |
| KFS-1 | Storm protection - Sturmleiste - Latte anti-tempete - Protezione anti vento - Stormverankering / beveiliging - Tormikinnitusliist  | 4 | 22x45 | 2050 |
| | Gable moulding - Giebelleiste - Planche de rive - Finitura per frontale e retro del tetto - Gevelljst - Viilulaud  | 4 | 18x120 | 1650 |
| HS8 | Screw for gable segment - Schrauben für deckblatt - Vis pour fixation losange de finition - Viti x frontali tetto - Schroef voor gevelpunt segment - Kruvi rombile  | 4 | 3.5x35 | |
| HS9 | Screw for gable moulding - Schrauben für giebelleiste - Vis pour fixation planche de rive - Vite per fissare finiture davanti e dietro del tetto - Schroef voor gevelljst - Kruvi viilulauale  | 24 | 3.5x50 | |

| Pos | Piece list - Stückliste - Liste des pièces - Elementi - Stuklijst - Tükitalabel 985x1336 TAK.1.106.TPSP.Kf DGP+A+ | 1/1 | Q | P (mm) | L (mm) |
|-----|---|---|----|-----------|-----------|
| | <p data-bbox="256 145 1286 174">Glass size - Glasgröße - Taille de la vitre - Misura del vetro - Glas afmeting - Klaasi mõõt: 363x1158 mm</p>   <p data-bbox="1364 342 1493 371">885x1240 mm</p> | | | | |
| FS2 | <p data-bbox="256 1951 1023 2007">Window handle fittings - Fenstergriff - Poignee de fenetre - Maniglia c/ferramenta - Raamhendel -/grendel -/klink - Aknalink</p> |  | 1 | | |
| HS1 | <p data-bbox="256 2029 1107 2107">Screw for georgian bars - Schraube für sprossen - Vis pour croisillons - Viti per unire la griglia georgiana della finestra - Schroeven voor raamverdeling - Kruvi akna petteliistule</p> |  | 20 | 2.5x20 | |
| HS4 | <p data-bbox="256 2121 1091 2199">Screw for window fillet - Schraube für glasleiste - Vis de filet de fenetre - Vite per assemblaggio finestra - Schroef voor glaslijst - Kruvi akna kokkuvaltšiliistule</p> |  | 3 | 3x30 | |

| Pos | Piece list - Stückliste - Liste des pièces - Elementi - Stuklijst - Tükítabel 1244x1850 TUK.2.066.TPVP.MMKWe DGP+A+ | 1/1 | Q | P (mm) | L (mm) |
|------|---|---|----|-----------|-----------|
| | <p>Glass size - Glasgröße - Taille de la vitre - Misura del vetro - Glas afmeting - Klaasi mõõt: 389x1085 mm</p>   <p>1144x1766 mm</p> | | | | |
| HS1 | Screw for georgian bars - Schraube für sprossen - Vis pour croisillons - Viti per unire la griglia georgiana della finestra - Schroeven voor raamverdeling - Kruvi ukse petteliistule |  | 20 | 2.5x20 | |
| HS4 | Screw for door fillet - Schraube zur Befestigung Türleiste - Vis pour fixation baguette d'arret de porte - Viti per massellino della porta - Schroef voor deurlijst - Kruvi ukse kokkuvaltšiliistule |  | 5 | 3x30 | |
| HS16 | Screw for door jamb - Schraube für Türrahmen - Vis de fixation partie haute avec montants du cadre de porte - Viti x fissaggio montanti porte - Schroef voor deurkozijn - Kruvi ukse lengile |  | 4 | 5x90 | |
| HS25 | Screw for doorstep - Schrauben für swelle - Vis pour fixation barre de seuil - Vite per soglia della porta - Schroef voor deurdorpel - Kruvi lävepakule |  | 3 | 4.5x65 | |
| MH | Male bolt hinge for door - Türband - Partie male de paumelle de porte - Cerniera anube x porta - Scharnier bout - Reguleeritav polthing isane |  | 6 | 14x80 | |
| HC | Covers for door hinges - Schutzkappe für Türband - Couverture de paumelle de porte - Copertura delle cerniere della porta - Afdek kap voor deurscharnier - Reguleeritava polthinge kate |  | 12 | | |
| TL4 | Door handle fittings - Türgriff - Poignée de porte - Maniglie - Deurhendel klink - Ukse käepide |  | 1 | | |
| TL5 | Set of door lock covers - Schlossblenden - Set de garnitures de porte - Copertura serrature - Slot sluitplaat set - Ukse lukuplaat |  | 1 | | |
| | Cylinder lock - Zylinderschloss - Barillet de porte - Serratura - Cylinder slot - Ukse lukusüdamik |  | 1 | 30x35 | |
| | Striker for barrel bolt - Hülse für Grendelriegel - Gache au sol du targette - Boccola per fermo della porta - Huls voor vergrendelingsschuif - Vasturaud ukse servariivile |  | 2 | | |

DANCOVER[®]

.com

Contact information

Austria



Belgium



Croatia



Denmark



Estonia

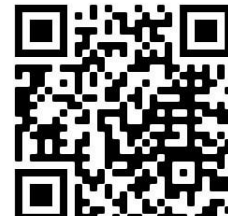

Finland



France



Germany



Ireland



Italy



Latvia



Lithuania



Nederland



Norway



Poland



Portugal



Spain



Sweden



Switzerland



UK



For more information please visit: www.dancovershop.com